

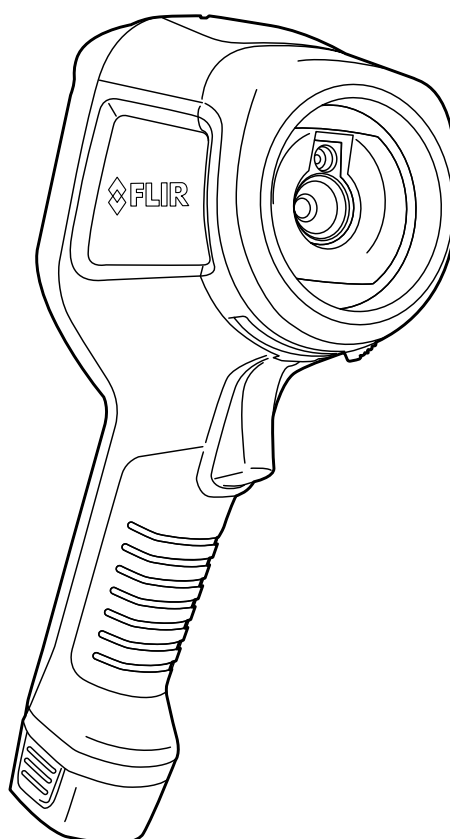

---

# User's manual FLIR Ex series







---

# User's manual FLIR Ex series



# Table of contents

---

<b>1</b>	<b>Disclaimers</b> .....	<b>1</b>
1.1	Legal disclaimer .....	1
1.2	Usage statistics .....	1
1.3	U.S. Government Regulations .....	1
1.4	Copyright .....	1
1.5	Quality assurance .....	1
1.6	Patents .....	1
1.7	EULA Terms .....	1
1.8	EULA Terms .....	1
<b>2</b>	<b>Safety information</b> .....	<b>2</b>
<b>3</b>	<b>Notice to user</b> .....	<b>5</b>
3.1	Calibration .....	5
3.2	Accuracy .....	5
3.3	Disposal of electronic waste .....	5
3.4	Training .....	5
3.5	Documentation updates .....	5
3.6	Important note about this manual .....	6
3.7	Note about authoritative versions .....	6
<b>4</b>	<b>Customer help</b> .....	<b>7</b>
4.1	General .....	7
4.2	Submitting a question .....	7
4.3	Downloads .....	7
<b>5</b>	<b>Quick Start Guide</b> .....	<b>8</b>
5.1	Procedure .....	8
<b>6</b>	<b>Description</b> .....	<b>9</b>
6.1	Camera parts .....	9
6.1.1	Figure .....	9
6.1.2	Explanation .....	9
6.2	Keypad .....	10
6.2.1	Figure .....	10
6.2.2	Explanation .....	10
6.3	Connectors .....	11
6.3.1	Figure .....	11
6.3.2	Explanation .....	11
6.4	Screen elements .....	11
6.4.1	Figure .....	11
6.4.2	Explanation .....	11
<b>7</b>	<b>Operation</b> .....	<b>12</b>
7.1	Charging the battery .....	12
7.1.1	Charging the battery using the FLIR power supply .....	12
7.1.2	Charging the battery using the FLIR stand-alone battery charger. ....	12
7.1.3	Charging the battery using a USB cable .....	12
7.2	Turning on and turning off the camera .....	13
7.3	Saving an image .....	13
7.3.1	General .....	13
7.3.2	Image capacity .....	13
7.3.3	Naming convention .....	13
7.3.4	Procedure .....	13
7.4	Recalling an image .....	13
7.4.1	General .....	13
7.4.2	Procedure .....	13
7.5	Deleting an image .....	14
7.5.1	General .....	14

## Table of contents

---

	7.5.2 Procedure .....	14
7.6	Deleting all images.....	14
	7.6.1 General.....	14
	7.6.2 Procedure .....	14
7.7	Measuring a temperature using a spotmeter .....	14
	7.7.1 General.....	14
	7.7.2 Procedure .....	14
7.8	Measuring the hottest temperature within an area .....	14
	7.8.1 General.....	14
	7.8.2 Procedure .....	15
7.9	Measuring the coldest temperature within an area.....	15
	7.9.1 General.....	15
	7.9.2 Procedure .....	15
7.10	Hiding measurement tools .....	15
	7.10.1 Procedure .....	15
7.11	Changing the color palette .....	15
	7.11.1 General.....	15
	7.11.2 Procedure .....	15
7.12	Working with color alarms .....	15
	7.12.1 General.....	15
	7.12.2 Image examples .....	16
	7.12.3 Procedure .....	16
7.13	Changing image mode.....	17
	7.13.1 General.....	17
	7.13.2 Procedure .....	18
7.14	Changing the temperature scale mode .....	18
	7.14.1 General.....	18
	7.14.2 When to use <i>Manual</i> mode.....	18
	7.14.3 Procedure .....	19
7.15	Changing the camera temperature range .....	19
	7.15.1 General.....	19
	7.15.2 Procedure .....	20
7.16	Setting the emissivity as a surface property .....	20
	7.16.1 General.....	20
	7.16.2 Procedure .....	20
7.17	Setting the emissivity as a custom material .....	20
	7.17.1 General.....	20
	7.17.2 Procedure .....	20
7.18	Changing the emissivity as a custom value .....	21
	7.18.1 General.....	21
	7.18.2 Procedure .....	21
7.19	Changing the reflected apparent temperature .....	21
	7.19.1 General.....	21
	7.19.2 Procedure .....	21
7.20	Changing the distance between the object and the camera .....	22
	7.20.1 General.....	22
	7.20.2 Procedure .....	22
7.21	Performing a non-uniformity correction (NUC) .....	22
	7.21.1 What is a non-uniformity correction?.....	22
	7.21.2 When to perform a non-uniformity correction? .....	22
	7.21.3 Procedure .....	22
7.22	Configuring Wi-Fi.....	22
	7.22.1 Setting up a peer-to-peer connection (most common use) .....	22
	7.22.2 Connecting the camera to a wireless local area network (less common use) .....	23

**Table of contents**

---

7.23	Changing the settings .....	23
7.23.1	General.....	23
7.23.2	Procedure .....	24
7.24	Updating the camera .....	24
7.24.1	General.....	24
7.24.2	Procedure .....	24
<b>8</b>	<b>Mechanical drawings .....</b>	<b>25</b>
<b>9</b>	<b>CE Declaration of conformity .....</b>	<b>28</b>
<b>10</b>	<b>Cleaning the camera .....</b>	<b>30</b>
10.1	Camera housing, cables, and other items.....	30
10.1.1	Liquids.....	30
10.1.2	Equipment.....	30
10.1.3	Procedure .....	30
10.2	Infrared lens .....	30
10.2.1	Liquids.....	30
10.2.2	Equipment.....	30
10.2.3	Procedure .....	30
<b>11</b>	<b>Application examples.....</b>	<b>31</b>
11.1	Moisture & water damage .....	31
11.1.1	General.....	31
11.1.2	Figure.....	31
11.2	Faulty contact in socket .....	31
11.2.1	General.....	31
11.2.2	Figure.....	31
11.3	Oxidized socket.....	32
11.3.1	General.....	32
11.3.2	Figure.....	32
11.4	Insulation deficiencies.....	33
11.4.1	General.....	33
11.4.2	Figure.....	33
11.5	Draft .....	33
11.5.1	General.....	33
11.5.2	Figure.....	33
<b>12</b>	<b>Thermographic measurement techniques .....</b>	<b>35</b>
12.1	Introduction .....	35
12.2	Emissivity.....	35
12.2.1	Finding the emissivity of a sample .....	35
12.3	Reflected apparent temperature.....	39
12.4	Distance .....	39
12.5	Relative humidity .....	39
12.6	Other parameters.....	39
<b>13</b>	<b>About calibration.....</b>	<b>40</b>
13.1	Introduction .....	40
13.2	Definition—what is calibration? .....	40
13.3	Camera calibration at FLIR Systems .....	40
13.4	The differences between a calibration performed by a user and that performed directly at FLIR Systems.....	41
13.5	Calibration, verification and adjustment.....	41
13.6	Non-uniformity correction.....	42
13.7	Thermal image adjustment (thermal tuning) .....	42
<b>14</b>	<b>About FLIR Systems .....</b>	<b>43</b>
14.1	More than just an infrared camera .....	44
14.2	Sharing our knowledge .....	44
14.3	Supporting our customers.....	45





## 1.1 Legal disclaimer

For warranty terms, please refer to <https://www.flir.com/warranty>.

## 1.2 Usage statistics

FLIR Systems reserves the right to gather anonymous usage statistics to help maintain and improve the quality of our software and services.

## 1.3 U.S. Government Regulations

This product may be subject to U.S. Export Regulations. Please send any inquiries to [exportquestions@flir.com](mailto:exportquestions@flir.com).

## 1.4 Copyright

© 2019, FLIR Systems, Inc. All rights reserved worldwide. No parts of the software including source code may be reproduced, transmitted, transcribed or translated into any language or computer language in any form or by any means, electronic, magnetic, optical, manual or otherwise, without the prior written permission of FLIR Systems.

The documentation must not, in whole or part, be copied, photocopied, reproduced, translated or transmitted to any electronic medium or machine readable form without prior consent, in writing, from FLIR Systems.

Names and marks appearing on the products herein are either registered trademarks or trademarks of FLIR Systems and/or its subsidiaries. All other trademarks, trade names or company names referenced herein are used for identification only and are the property of their respective owners.

## 1.5 Quality assurance

The Quality Management System under which these products are developed and manufactured has been certified in accordance with the ISO 9001 standard.

FLIR Systems is committed to a policy of continuous development; therefore we reserve the right to make changes and improvements on any of the products without prior notice.

## 1.6 Patents









This product is protected by patents, design patents, patents pending, or design patents pending. Please refer to the FLIR Systems' patent registry: <https://www.flir.com/patentnotices>.













## 1.7 EULA Terms











Qt4 Core and Qt4 GUI, Copyright ©2013 Nokia Corporation and FLIR Systems AB. This Qt library is a free software; you can redistribute it and/or modify it under the terms of the GNU Lesser General Public License as published by the Free Software Foundation; either version 2.1 of the License, or (at your option) any later version. This library is distributed in the hope that it will be useful, but WITHOUT ANY WARRANTY; without even the implied warranty of MERCHANTABILITY or FITNESS FOR A PARTICULAR PURPOSE. See the GNU Lesser General Public License, <http://www.gnu.org/licenses/lgpl-2.1.html>. The source code for the libraries Qt4 Core and Qt4 GUI may be requested from FLIR Systems AB.

## 1.8 EULA Terms

- You have acquired a device ("INFRARED CAMERA") that includes software licensed by FLIR Systems AB from Microsoft Licensing, GP or its affiliates ("MS"). Those installed software products of MS origin, as well as associated media, printed materials, and "online" or electronic documentation ("SOFTWARE") are protected by international intellectual property laws and treaties. The SOFTWARE is licensed, not sold. All rights reserved.
- IF YOU DO NOT AGREE TO THIS END USER LICENSE AGREEMENT ("EULA"), DO NOT USE THE DEVICE OR COPY THE SOFTWARE. INSTEAD, PROMPTLY CONTACT FLIR Systems AB FOR INSTRUCTIONS ON RETURN OF THE UNUSED DEVICE(S) FOR A REFUND. **ANY USE OF THE SOFTWARE, INCLUDING BUT NOT LIMITED TO USE ON THE DEVICE, WILL CONSTITUTE YOUR AGREEMENT TO THIS EULA (OR RATIFICATION OF ANY PREVIOUS CONSENT).**
- **GRANT OF SOFTWARE LICENSE.** This EULA grants you the following license:
  - You may use the SOFTWARE only on the DEVICE.
  - **NOT FAULT TOLERANT.** THE SOFTWARE IS NOT FAULT TOLERANT. FLIR Systems AB HAS INDEPENDENTLY DETERMINED HOW TO USE THE SOFTWARE IN THE DEVICE, AND MS HAS RELIED UPON FLIR Systems AB TO CONDUCT SUFFICIENT TESTING TO DETERMINE THAT THE SOFTWARE IS SUITABLE FOR SUCH USE.
  - **NO WARRANTIES FOR THE SOFTWARE.** THE SOFTWARE is provided "AS IS" and with all faults. THE ENTIRE RISK AS TO SATISFACTORY QUALITY, PERFORMANCE, ACCURACY, AND EFFORT (INCLUDING LACK OF NEGLIGENCE) IS WITH YOU. ALSO, THERE IS NO WARRANTY AGAINST INTERFERENCE WITH YOUR ENJOYMENT OF THE SOFTWARE OR AGAINST INFRINGEMENT. IF YOU HAVE RECEIVED ANY WARRANTIES REGARDING THE DEVICE OR THE SOFTWARE, THOSE WARRANTIES DO NOT ORIGINATE FROM, AND ARE NOT BINDING ON, MS.
  - No Liability for Certain Damages. **EXCEPT AS PROHIBITED BY LAW, MS SHALL HAVE NO LIABILITY FOR ANY INDIRECT, SPECIAL, CONSEQUENTIAL OR INCIDENTAL DAMAGES ARISING FROM OR IN CONNECTION WITH THE USE OR PERFORMANCE OF THE SOFTWARE. THIS LIMITATION SHALL APPLY EVEN IF ANY REMEDY FAILS OF ITS ESSENTIAL PURPOSE. IN NO EVENT SHALL MS BE LIABLE FOR ANY AMOUNT IN EXCESS OF U.S. TWO HUNDRED FIFTY DOLLARS (U.S.\$250.00).**
  - **Limitations on Reverse Engineering, Decompilation, and Disassembly.** You may not reverse engineer, decompile, or disassemble the SOFTWARE, except and only to the extent that such activity is expressly permitted by applicable law notwithstanding this limitation.
  - **SOFTWARE TRANSFER ALLOWED BUT WITH RESTRICTIONS.** You may permanently transfer rights under this EULA only as part of a permanent sale or transfer of the Device, and only if the recipient agrees to this EULA. If the SOFTWARE is an upgrade, any transfer must also include all prior versions of the SOFTWARE.
  - **EXPORT RESTRICTIONS.** You acknowledge that SOFTWARE is subject to U.S. export jurisdiction. You agree to comply with all applicable international and national laws that apply to the SOFTWARE, including the U.S. Export Administration Regulations, as well as end-user, end-use and destination restrictions issued by U.S. and other governments. For additional information see <http://www.microsoft.com/exporting/>.

 <b>WARNING</b>
<p><b>Applicability:</b> Class B digital devices.</p> <p>This equipment has been tested and found to comply with the limits for a Class B digital device, pursuant to Part 15 of the FCC Rules. These limits are designed to provide reasonable protection against harmful interference in a residential installation. This equipment generates, uses and can radiate radio frequency energy and, if not installed and used in accordance with the instructions, may cause harmful interference to radio communications. However, there is no guarantee that interference will not occur in a particular installation. If this equipment does cause harmful interference to radio or television reception, which can be determined by turning the equipment off and on, the user is encouraged to try to correct the interference by one or more of the following measures:</p> <ul style="list-style-type: none"> <li>• Reorient or relocate the receiving antenna.</li> <li>• Increase the separation between the equipment and receiver.</li> <li>• Connect the equipment into an outlet on a circuit different from that to which the receiver is connected.</li> <li>• Consult the dealer or an experienced radio/TV technician for help.</li> </ul>
 <b>WARNING</b>
<p><b>Applicability:</b> Digital devices subject to 15.19/RSS-210.</p> <p><b>NOTICE:</b> This device complies with Part 15 of the FCC Rules and with RSS-210 of Industry Canada. Operation is subject to the following two conditions:</p> <ol style="list-style-type: none"> <li>1. this device may not cause harmful interference, and</li> <li>2. this device must accept any interference received, including interference that may cause undesired operation.</li> </ol>
 <b>WARNING</b>
<p><b>Applicability:</b> Digital devices subject to 15.21.</p> <p><b>NOTICE:</b> Changes or modifications made to this equipment not expressly approved by FLIR Systems may void the FCC authorization to operate this equipment.</p>
 <b>WARNING</b>
<p><b>Applicability:</b> Digital devices subject to 2.1091/2.1093/OET Bulletin 65.</p> <p><b>Radiofrequency radiation exposure Information:</b> The radiated output power of the device is below the FCC/IC radio frequency exposure limits. Nevertheless, the device shall be used in such a manner that the potential for human contact during normal operation is minimized.</p>
 <b>WARNING</b>
<p>This device is granted pursuant to the Japanese Radio Law (電波法) and the Japanese Telecommunications Business Law (電気通信事業法). This device should not be modified (otherwise the granted designation number will become invalid)</p>
 <b>WARNING</b>
<p>Do not disassemble or do a modification to the battery. The battery contains safety and protection devices which, if damage occurs, can cause the battery to become hot, or cause an explosion or an ignition.</p>
 <b>WARNING</b>
<p>If there is a leak from the battery and you get the fluid in your eyes, do not rub your eyes. Flush well with water and immediately get medical care. The battery fluid can cause injury to your eyes if you do not do this.</p>
 <b>WARNING</b>
<p>Do not continue to charge the battery if it does not become charged in the specified charging time. If you continue to charge the battery, it can become hot and cause an explosion or ignition. Injury to persons can occur.</p>

 <b>WARNING</b>
Only use the correct equipment to remove the electrical power from the battery. If you do not use the correct equipment, you can decrease the performance or the life cycle of the battery. If you do not use the correct equipment, an incorrect flow of current to the battery can occur. This can cause the battery to become hot, or cause an explosion. Injury to persons can occur.
 <b>WARNING</b>
Make sure that you read all applicable MSDS (Material Safety Data Sheets) and warning labels on containers before you use a liquid. The liquids can be dangerous. Injury to persons can occur.
 <b>CAUTION</b>
Do not point the infrared camera (with or without the lens cover) at strong energy sources, for example, devices that cause laser radiation, or the sun. This can have an unwanted effect on the accuracy of the camera. It can also cause damage to the detector in the camera.
 <b>CAUTION</b>
Do not use the camera in temperatures more than +50°C (+122°F), unless other information is specified in the user documentation or technical data. High temperatures can cause damage to the camera.
 <b>CAUTION</b>
Do not attach the batteries directly to a car's cigarette lighter socket, unless FLIR Systems supplies a specific adapter to connect the batteries to a cigarette lighter socket. Damage to the batteries can occur.
 <b>CAUTION</b>
Do not connect the positive terminal and the negative terminal of the battery to each other with a metal object (such as wire). Damage to the batteries can occur.
 <b>CAUTION</b>
Do not get water or salt water on the battery, or permit the battery to become wet. Damage to the batteries can occur.
 <b>CAUTION</b>
Do not make holes in the battery with objects. Damage to the battery can occur.
 <b>CAUTION</b>
Do not hit or cause shocks to the battery. Damage to the battery can occur.
 <b>CAUTION</b>
Do not put the batteries in or near a fire, or into direct sunlight. When the battery becomes hot, the built-in safety equipment becomes energized and can stop the battery charging procedure. If the battery becomes hot, damage can occur to the safety equipment and this can cause more heat, damage or ignition of the battery.
 <b>CAUTION</b>
Do not put the battery on or near fires, stoves, or other high-temperature locations. Damage to the battery and injury to persons can occur.
 <b>CAUTION</b>
Do not solder directly onto the battery. Damage to the battery can occur.

 <b>CAUTION</b>
Do not use the battery if, when you use, charge, or put the battery in storage, there is an unusual smell from the battery, the battery feels hot, changes color, changes shape, or is in an unusual condition. Speak with your sales office if one or more of these problems occurs. Damage to the battery and injury to persons can occur.
 <b>CAUTION</b>
Only use a specified battery charger when you charge the battery. Damage to the battery can occur if you do not do this.
 <b>CAUTION</b>
Only use a specified battery for the camera. Damage to the camera and the battery can occur if you do not do this.
 <b>CAUTION</b>
The temperature range through which you can charge the battery is $\pm 0^{\circ}\text{C}$ to $+45^{\circ}\text{C}$ ( $+32^{\circ}\text{F}$ to $+113^{\circ}\text{F}$ ), except for the Korean market where the approved range is $+10^{\circ}\text{C}$ to $+45^{\circ}\text{C}$ ( $+50^{\circ}\text{F}$ to $+113^{\circ}\text{F}$ ). If you charge the battery at temperatures out of this range, it can cause the battery to become hot or to break. It can also decrease the performance or the life cycle of the battery.
 <b>CAUTION</b>
The temperature range through which you can remove the electrical power from the battery is $-15^{\circ}\text{C}$ to $+50^{\circ}\text{C}$ ( $+5^{\circ}\text{F}$ to $+122^{\circ}\text{F}$ ), unless other information is specified in the user documentation or technical data. If you operate the battery out of this temperature range, it can decrease the performance or the life cycle of the battery.
 <b>CAUTION</b>
When the battery is worn, apply insulation to the terminals with adhesive tape or equivalent materials before you discard it. Damage to the battery and injury to persons can occur if you do not do this.
 <b>CAUTION</b>
Remove any water or moisture on the battery before you install it. Damage to the battery can occur if you do not do this.
 <b>CAUTION</b>
Do not apply solvents or equivalent liquids to the camera, the cables, or other items. Damage to the battery and injury to persons can occur.
 <b>CAUTION</b>
Be careful when you clean the infrared lens. The lens has an anti-reflective coating which is easily damaged. Damage to the infrared lens can occur.
 <b>CAUTION</b>
Do not use too much force to clean the infrared lens. This can cause damage to the anti-reflective coating.

**Note** The encapsulation rating is only applicable when all the openings on the camera are sealed with their correct covers, hatches, or caps. This includes the compartments for data storage, batteries, and connectors.

## 3.1 Calibration

We recommend that you send in the camera for calibration once a year. Contact your local sales office for instructions on where to send the camera.

## 3.2 Accuracy

For very accurate results, we recommend that you wait 5 minutes after you have started the camera before measuring a temperature.

## 3.3 Disposal of electronic waste

Electrical and electronic equipment (EEE) contains materials, components and substances that may be hazardous and present a risk to human health and the environment when waste electrical and electronic equipment (WEEE) is not handled correctly.

Equipment marked with the below crossed-out wheeled bin is electrical and electronic equipment. The crossed-out wheeled bin symbol indicates that waste electrical and electronic equipment should not be discarded together with unseparated household waste, but must be collected separately.

For this purpose all local authorities have established collection schemes under which residents can dispose waste electrical and electronic equipment at a recycling centre or other collection points, or WEEE will be collected directly from households. More detailed information is available from the technical administration of the relevant local authority.



## 3.4 Training

To read about infrared training, visit:

- <http://www.infraredtraining.com>
- <http://www.irtraining.com>
- <http://www.irtraining.eu>

## 3.5 Documentation updates

Our manuals are updated several times per year, and we also issue product-critical notifications of changes on a regular basis.

To access the latest manuals, translations of manuals, and notifications, go to the Download tab at:

It only takes a few minutes to register online. In the download area you will also find the latest releases of manuals for our other products, as well as manuals for our historical and obsolete products.

### **3.6 Important note about this manual**

FLIR Systems issues generic manuals that cover several cameras within a model line.

This means that this manual may contain descriptions and explanations that do not apply to your particular camera model.

### **3.7 Note about authoritative versions**

The authoritative version of this publication is English. In the event of divergences due to translation errors, the English text has precedence.

Any late changes are first implemented in English.

## 4.1 General

## 4.2 Submitting a question

To submit a question to the customer help team, you must be a registered user. It only takes a few minutes to register online. If you only want to search the knowledgebase for existing questions and answers, you do not need to be a registered user.

When you want to submit a question, make sure that you have the following information to hand:

- The camera model
- The camera serial number
- The communication protocol, or method, between the camera and your device (for example, SD card reader, HDMI, Ethernet, USB, or FireWire)
- Device type (PC/Mac/iPhone/iPad/Android device, etc.)
- Version of any programs from FLIR Systems
- Full name, publication number, and revision number of the manual

## 4.3 Downloads

On the customer help site you can also download the following, when applicable for the product:

- Firmware updates for your infrared camera.
- Program updates for your PC/Mac software.
- Freeware and evaluation versions of PC/Mac software.
- User documentation for current, obsolete, and historical products.
- Mechanical drawings (in \*.dxf and \*.pdf format).
- Cad data models (in \*.stp format).
- Application stories.
- Technical datasheets.

## 5.1 Procedure

Follow this procedure:

1. Charge the battery. You can do this in three different ways:

- Charge the battery using the FLIR stand-alone battery charger.
- Charge the battery using the FLIR power supply.
- Charge the battery using a USB cable connected to a computer.

**Note** Charging the camera using a USB cable connected to a computer takes *considerably* longer than using the FLIR power supply or the FLIR stand-alone battery charger.

2. Push the On/off button  to turn on the camera.
3. Open the lens cap by pushing the lens cap lever.
4. Aim the camera toward your target of interest.
5. Pull the trigger to save an image.

(Optional steps)

6. Install FLIR Tools on your computer.
7. Start FLIR Tools.
8. Connect the camera to your computer, using the USB cable.
9. Import the images into FLIR Tools.
10. Create a PDF report in FLIR Tools.



## 6.1 Camera parts

### 6.1.1 Figure

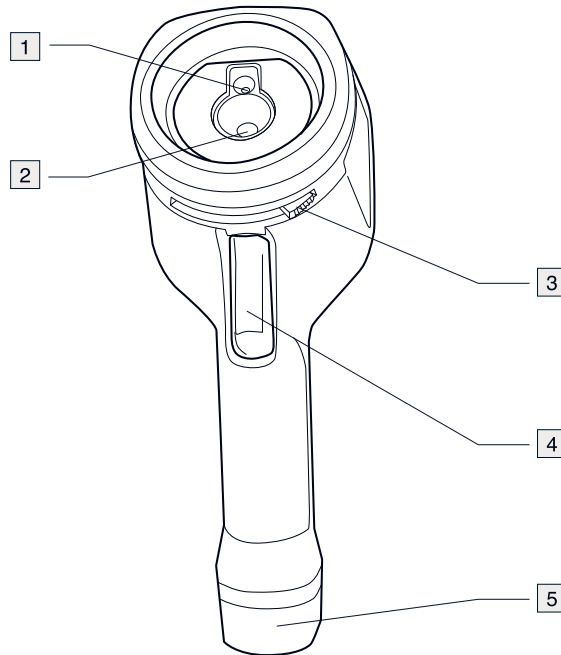

### 6.1.2 Explanation





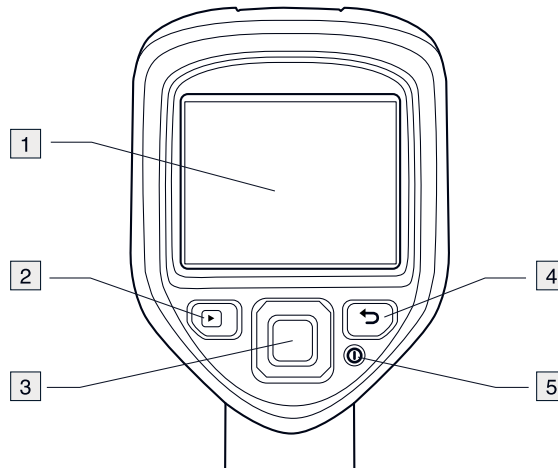

1. Digital camera lens.
2. Infrared lens.
3. Lever to open and close the lens cap.
4. Trigger to save images.
5. Battery.

## 6.2 Keypad

### 6.2.1 Figure



### 6.2.2 Explanation

1. Camera screen.
2. Archive button .  
Function:
  - Push to open the image archive.
3. Navigation pad.  
Function:
  - Push left/right or up/down to navigate in menus, submenus, and dialog boxes.
  - Push the center to confirm.
4. Cancel button .  
Function:
  - Push to cancel a choice.
  - Push to go back into the menu system.
5. On/off button .  
Function:
  - Push the  button to turn on the camera.
  - Push and hold the  button for less than 5 seconds to put the camera in standby mode. The camera then automatically turns off after 48 hours.
  - Push and hold the  button for more than 10 seconds to turn off the camera.

## 6.3 Connectors

### 6.3.1 Figure

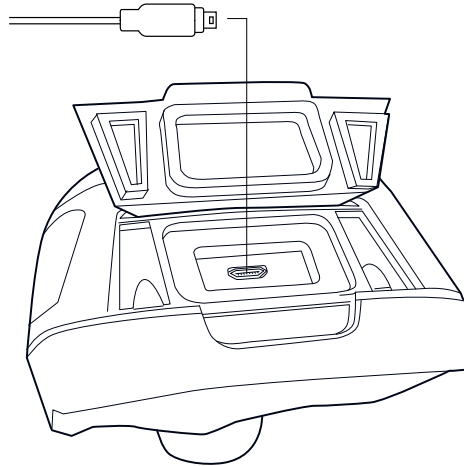

### 6.3.2 Explanation

The purpose of this USB mini-B connector is the following:

- Charging the battery using the FLIR power supply.
- Charging the battery using a USB cable connected to a computer.

**Note** Charging the camera using a USB cable connected to a computer takes *considerably* longer than using the FLIR power supply or the FLIR stand-alone battery charger.

- Moving images from the camera to a computer for further analysis in FLIR Tools.

**Note** Install FLIR Tools on your computer before you move the images.

## 6.4 Screen elements

### 6.4.1 Figure

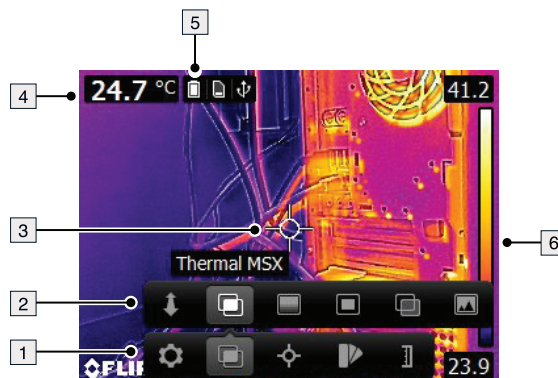

### 6.4.2 Explanation

1. Main menu toolbar.
2. Submenu toolbar.
3. Spotmeter.
4. Result table.
5. Status icons.
6. Temperature scale.

## 7.1 Charging the battery



### WARNING

Make sure that you install the socket-outlet near the equipment and that it is easy to get access to.

### 7.1.1 Charging the battery using the FLIR power supply

Follow this procedure:

1. Connect the power supply to a wall outlet.
2. Connect the power supply cable to the USB connector on the camera.



### NOTE

The charging time for a fully depleted battery is 2 hours.

### 7.1.2 Charging the battery using the FLIR stand-alone battery charger.

Follow this procedure:

1. Connect the stand-alone battery charger to a wall outlet.
2. Remove the battery from the camera.

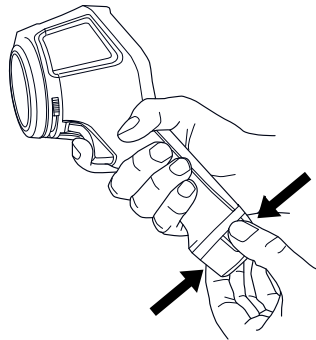

3. Put the battery into the stand-alone battery charger.



### NOTE

- The charging time for a fully depleted battery is 2 hours.
- The battery is being charged when the blue LED is flashing.
- The battery is fully charged when the blue LED is continuous.

### 7.1.3 Charging the battery using a USB cable

Follow this procedure:

1. Connect the camera to a computer using a USB cable.





### NOTE

- To charge the camera, the computer must be turned on.
- Charging the camera using a USB cable connected to a computer takes *considerably* longer than using the FLIR power supply or the FLIR stand-alone battery charger.

---

## 7.2 Turning on and turning off the camera

- Push the  button to turn on the camera.
- Push and hold the  button for less than 5 seconds to put the camera in standby mode. The camera then automatically turns off after 48 hours.
- Push and hold the  button for more than 10 seconds to turn off the camera.

## 7.3 Saving an image

### 7.3.1 General

You can save multiple images to the internal camera memory.

### 7.3.2 Image capacity

Approximately 500 images can be saved to the internal camera memory.

### 7.3.3 Naming convention

The naming convention for images is *FLIRxxxx.jpg*, where *xxxx* is a unique counter.

### 7.3.4 Procedure

Follow this procedure:

1. To save an image, pull the trigger.

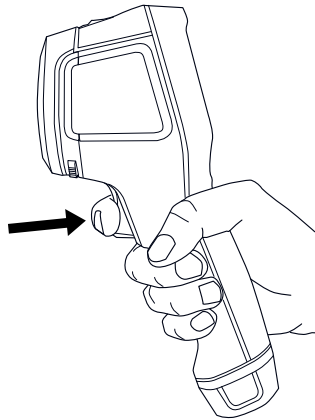



## 7.4 Recalling an image

### 7.4.1 General

When you save an image, it is stored in the internal camera memory. To display the image again, you can recall it from the internal camera memory.

### 7.4.2 Procedure

Follow this procedure:

1. Push the Archive button .
2. Push the navigation pad left/right or up/down to select the image you want to view.
3. Push the center of the navigation pad. This displays the selected image.
4. To return to live mode, push the Cancel button  repeatedly or push the Archive button .



## 7.5 Deleting an image

### 7.5.1 General

You can delete one or more images from the internal camera memory.

### 7.5.2 Procedure

Follow this procedure:

1. Push the Archive button .
2. Push the navigation pad left/right or up/down to select the image you want to view.
3. Push the center of the navigation pad. This displays the selected image.
4. Push the center of the navigation pad. This displays a toolbar.
5. On the toolbar, select *Delete* .

## 7.6 Deleting all images

### 7.6.1 General

You can delete all images from the internal camera memory.

### 7.6.2 Procedure

Follow this procedure:

1. Push the center of the navigation pad. This displays a toolbar.
2. On the toolbar, select *Settings* . This displays a dialog box.
3. In the dialog box, select *Device settings*. This displays a dialog box.
4. In the dialog box, select *Reset options*. This displays a dialog box.
5. In the dialog box, select *Delete all saved images*.



## 7.7 Measuring a temperature using a spotmeter

### 7.7.1 General

You can measure a temperature using a spotmeter. This will display the temperature at the position of the spotmeter on the screen.

### 7.7.2 Procedure

Follow this procedure:

1. Push the center of the navigation pad. This displays a toolbar.
2. On the toolbar, select *Measurement* . This displays a toolbar.
3. On the toolbar, select *Center spot* .  
The temperature at the position of the spotmeter will now be displayed in the top left corner of the screen.



## 7.8 Measuring the hottest temperature within an area

### 7.8.1 General

You can measure the hottest temperature within an area. This displays a moving spotmeter that indicates the hottest temperature.

### 7.8.2 Procedure

Follow this procedure:

1. Push the center of the navigation pad. This displays a toolbar.
2. On the toolbar, select *Measurement* . This displays a toolbar.
3. On the toolbar, select *Hot spot* .



## 7.9 Measuring the coldest temperature within an area

### 7.9.1 General

You can measure the coldest temperature within an area. This displays a moving spot-meter that indicates the coldest temperature.

### 7.9.2 Procedure



Follow this procedure:

1. Push the center of the navigation pad. This displays a toolbar.
2. On the toolbar, select *Measurement* . This displays a toolbar.
3. On the toolbar, select *Cold spot* .

## 7.10 Hiding measurement tools

### 7.10.1 Procedure

Follow this procedure:

1. Push the center of the navigation pad. This displays a toolbar.
2. On the toolbar, select *Measurement* . This displays a toolbar.
3. On the toolbar, select *No measurements* .

## 7.11 Changing the color palette

### 7.11.1 General

You can change the color palette that the camera uses to display different temperatures. A different palette can make it easier to analyze an image.

### 7.11.2 Procedure

Follow this procedure:

1. Push the center of the navigation pad. This displays a toolbar.
2. On the toolbar, select *Color* . This displays a toolbar.
3. On the toolbar, select a new color palette.

## 7.12 Working with color alarms

### 7.12.1 General

By using color alarms (isotherms), anomalies can easily be discovered in an infrared image. The isotherm command applies a contrasting color to all pixels with a temperature above or below the specified temperature level.

### 7.12.2 Image examples

This table explains the different color alarms (isotherms).

Color alarm	Image
<i>Below alarm</i>	
<i>Above alarm</i>	

### 7.12.3 Procedure

Follow this procedure:

1. Push the center of the navigation pad. This displays a toolbar.
2. On the toolbar, select *Color* . This displays a toolbar.
3. On the toolbar, select the type of alarm:
  - *Below alarm*
  - *Above alarm*
4. Push the center of the navigation pad. The threshold temperature is displayed at the bottom of the screen.
5. To change the threshold temperature, push the navigation pad up/down.



## 7.13 Changing image mode

### 7.13.1 General

The camera can operate in five different image modes:

- *Thermal MSX* (Multi Spectral Dynamic Imaging): The camera displays an infrared image where the edges of the objects are enhanced.

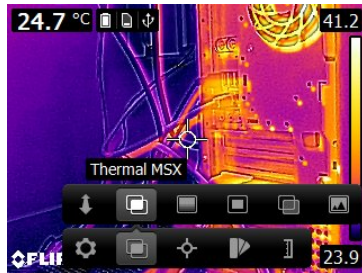

- *Thermal*: The camera displays a fully thermal image.



- *Picture-in-picture*: The camera displays a digital camera image with a superimposed infrared image frame.

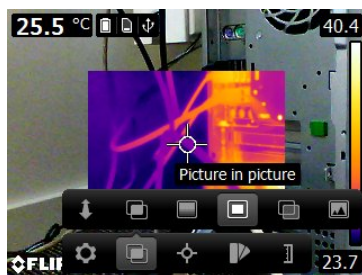

- *Thermal blending*: The camera displays a blended image that uses a mix of infrared pixels and digital photo pixels. The mixing level can be adjusted.





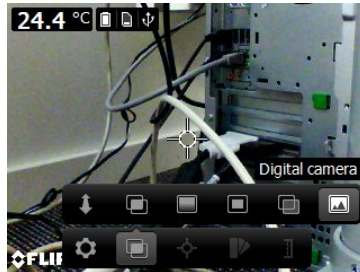



- *Digital camera*: The camera displays a digital camera image.



To display a good fusion image (*Thermal MSX*, *Picture-in-picture*, and *Thermal blending* modes), the camera must make adjustments to compensate for the small difference in position between the digital camera lens and the infrared lens. To adjust the image accurately, the camera requires the alignment distance (i.e., the distance to the object).

### 7.13.2 Procedure

Follow this procedure:

1. Push the center of the navigation pad. This displays a toolbar.
2. On the toolbar, select *Image mode* . This displays a toolbar.
3. On the toolbar, select one of the following:
  - *Thermal MSX* .
  - *Thermal* .
  - *Picture-in-picture* .
  - *Thermal blending* . This displays a dialog box where you can select the mixing level.
  - *Digital camera* .
4. If you have selected the *Thermal MSX*, *Picture-in-picture*, or *Thermal blending* mode, also set the distance to the object by doing the following:
  - On the *Image mode* toolbar, select *Alignment distance* . This displays a dialog box.
  - In the dialog box, select the distance to the object.

## 7.14 Changing the temperature scale mode

### 7.14.1 General

The camera can, depending on the camera model, operate in different temperature scale modes:

- *Auto mode*: In this mode, the camera is continuously auto-adjusted for the best image brightness and contrast.
- *Manual mode*: This mode allows manual adjustments of the temperature span and the temperature level.

### 7.14.2 When to use *Manual mode*

#### 7.14.2.1 Example 1

Here are two infrared images of a building. In the left image, which is auto-adjusted, the large temperature span between the clear sky and the heated building makes a correct analysis difficult. You can analyze the building in more detail if you change the temperature scale to values close to the temperature of the building.

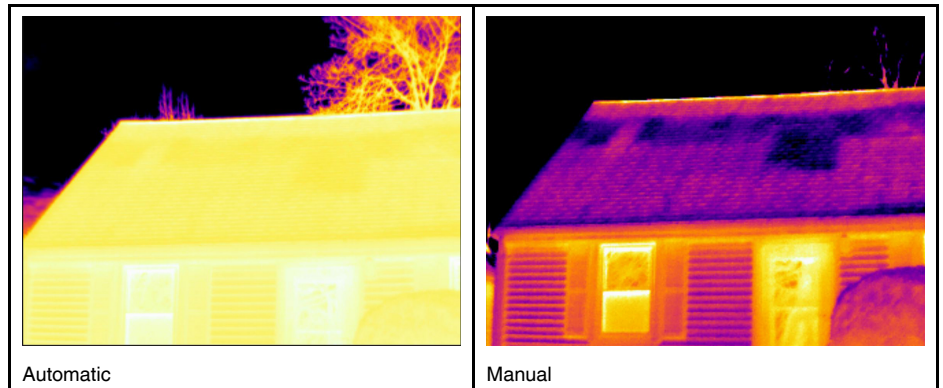

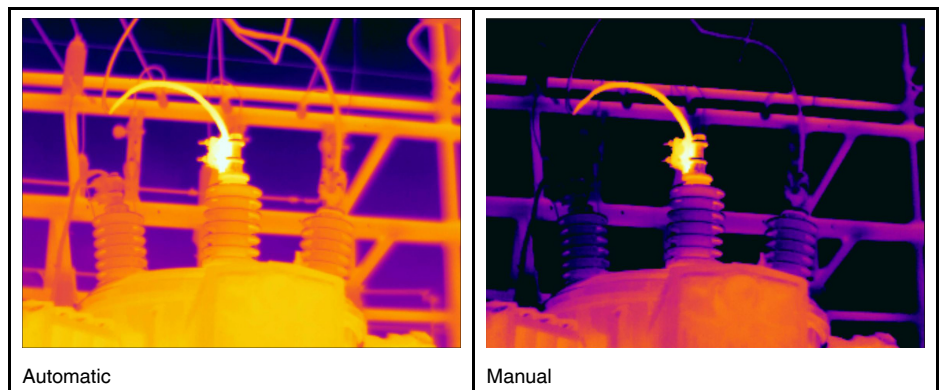

#### 7.14.2.2 Example 2

Here are two infrared images of an isolator in a power line. To make it easier to analyze the temperature variations in the isolator, the temperature scale in the right image has been changed to values close to the temperature of the isolator.



#### 7.14.3 Procedure

Follow this procedure:

1. Push the center of the navigation pad. This displays a toolbar.
2. On the toolbar, select *Temperature scale* . This displays a toolbar.
3. On the toolbar, select one of the following:
  - *Auto* 
  - *Manual* 
4. To change the temperature span and the temperature level in *Manual* mode, do the following:
  - Push the navigation pad left/right to select (highlight) the maximum and/or minimum temperature.
  - Push the navigation pad up/down to change the value of the highlighted temperature.

## 7.15 Changing the camera temperature range

### 7.15.1 General

The camera is calibrated for different temperature ranges. Available temperature range options are dependent on the camera model.

For accurate temperature measurements, you must change the *Camera temperature range* setting to suit the expected temperature of the object you are inspecting.

**Note** For more information, see section 13 *About calibration*, page 40.

### 7.15.2 Procedure

Follow this procedure:

1. Push the navigation pad to display the menu system.
2. Select  (*Settings*) and push the navigation pad. This displays the *Settings* menu.
3. Select *Camera temperature range* and push the navigation pad. This displays a dialog box.
4. Select the appropriate temperature range and push the navigation pad.

## 7.16 Setting the emissivity as a surface property

### 7.16.1 General

To measure temperatures accurately, the camera must know what kind of surface you are measuring. You can choose between the following surface properties:

- *Matt.*
- *Semi-matt.*
- *Semi-glossy.*

For more information about emissivity, see section 12 *Thermographic measurement techniques*, page 35.

### 7.16.2 Procedure

Follow this procedure:

1. Push the center of the navigation pad. This displays a toolbar.
2. On the toolbar, select *Settings* . This displays a dialog box.
3. In the dialog box, select *Measurement parameters*. This displays a dialog box.
4. In the dialog box, select *Emissivity*. This displays a dialog box.
5. In the dialog box, select one of the following:
  - *Matt.*
  - *Semi-matt.*
  - *Semi-glossy.*

## 7.17 Setting the emissivity as a custom material

### 7.17.1 General

Instead of specifying a surface property as matt, semi-matt or semi-glossy, you can specify a custom material from a list of materials.

For more information about emissivity, see section 12 *Thermographic measurement techniques*, page 35.

### 7.17.2 Procedure

Follow this procedure:

1. Push the center of the navigation pad. This displays a toolbar.
2. On the toolbar, select *Settings* . This displays a dialog box.
3. In the dialog box, select *Measurement parameters*. This displays a dialog box.
4. In the dialog box, select *Emissivity*. This displays a dialog box.
5. In the dialog box, select *Custom material*. This displays a list of materials with known emissivities.

6. In the list, select the material.

## 7.18 Changing the emissivity as a custom value

### 7.18.1 General

For very precise measurements, you may need to set the emissivity, instead of selecting a surface property or a custom material. You also need to understand how emissivity and reflectivity affect measurements, rather than just simply selecting a surface property.

Emissivity is a property that indicates how much radiation originates from an object as opposed to being reflected by it. A lower value indicates that a larger proportion is being reflected, while a high value indicates that a lower proportion is being reflected.

Polished stainless steel, for example, has an emissivity of 0.14, while a structured PVC floor typically has an emissivity of 0.93.

For more information about emissivity, see section 12 *Thermographic measurement techniques*, page 35.

### 7.18.2 Procedure

Follow this procedure:

1. Push the center of the navigation pad. This displays a toolbar.
2. On the toolbar, select *Settings* . This displays a dialog box.
3. In the dialog box, select *Measurement parameters*. This displays a dialog box.
4. In the dialog box, select *Emissivity*. This displays a dialog box.
5. In the dialog box, select *Custom value*. This displays a dialog box where you can set a custom value.

## 7.19 Changing the reflected apparent temperature

### 7.19.1 General

This parameter is used to compensate for the radiation reflected by the object. If the emissivity is low and the object temperature significantly different from that of the reflected temperature, it will be important to set and compensate for the reflected apparent temperature correctly.

For more information about reflected apparent temperature, see section 12 *Thermographic measurement techniques*, page 35.

### 7.19.2 Procedure

Follow this procedure:

1. Push the center of the navigation pad. This displays a toolbar.
2. On the toolbar, select *Settings* . This displays a dialog box.
3. In the dialog box, select *Measurement parameters*. This displays a dialog box.
4. In the dialog box, select *Reflected apparent temperature*. This displays a dialog box where you can set a value.

---

## 7.20 Changing the distance between the object and the camera

### 7.20.1 General

To measure temperatures accurately, the camera requires the distance between the camera and the object.

### 7.20.2 Procedure

Follow this procedure:

1. Push the center of the navigation pad. This displays a toolbar.
2. On the toolbar, select *Settings* . This displays a dialog box.
3. In the dialog box, select *Measurement parameters*. This displays a dialog box.
4. In the dialog box, select *Distance*. This displays a dialog box where you can select a distance.

## 7.21 Performing a non-uniformity correction (NUC)

### 7.21.1 What is a non-uniformity correction?

A non-uniformity correction is *an image correction carried out by the camera software to compensate for different sensitivities of detector elements and other optical and geometrical disturbances*<sup>1</sup>.

### 7.21.2 When to perform a non-uniformity correction?

The non-uniformity correction process should be carried out whenever the output image becomes spatially noisy. The output can become spatially noisy when the ambient temperature changes (such as from day to night operation, and vice versa).

### 7.21.3 Procedure

To perform a non-uniformity correction, push and hold the Image archive button  for more than 2 seconds.

## 7.22 Configuring Wi-Fi

Depending on your camera configuration, you can connect the camera to a wireless local area network (WLAN) using Wi-Fi, or let the camera provide Wi-Fi access to another device.

You can connect the camera in two different ways:

- *Most common use*: Setting up a peer-to-peer connection (also called an *ad hoc* or *P2P* connection). This method is primarily used with other devices, e.g., an iPhone or iPad.
- *Less common use*: Connecting the camera to a WLAN.

### 7.22.1 Setting up a peer-to-peer connection (most common use)

Follow this procedure:

1. Push the center of the navigation pad. This displays a toolbar.
2. On the toolbar, select *Settings* . This displays a dialog box.
3. Select *Device settings* and push the center of the navigation pad.

---

1. Definition from the impending international adoption of DIN 54190-3 (Non-destructive testing – Thermographic testing – Part 3: Terms and definitions).

- 
4. Select *Wi-Fi* and push the center of the navigation pad.
  5. Select *Share* and push the center of the navigation pad.
  6. (Optional step.) To display and change the parameters, select *Settings* and push the center of the navigation pad.
    - To change the channel (the channel that the camera is broadcasting on), select *Channel* and push the center of the navigation pad.
    - To activate WEP (encryption algorithm), select *WEP* and push the center of the navigation pad. This will check the *WEP* check box.
    - To change the WEP password, select *Password* and push the center of the navigation pad.

**Note** These parameters are set for your camera's network. They will be used by the external device to connect that device to the network.

### 7.22.2 Connecting the camera to a wireless local area network (less common use)

Follow this procedure:

1. Push the center of the navigation pad. This displays a toolbar.
2. On the toolbar, select *Settings* . This displays a dialog box.
3. Select *Device settings* and push the center of the navigation pad.
4. Select *Wi-Fi* and push the center of the navigation pad.
5. Select *Connect to network* and push the center of the navigation pad.
6. To display a list of the available networks, select *Networks* and push the center of the navigation pad.
7. Select one of the available networks.  
Password-protected networks are indicated with a padlock icon, and for these you will need to enter a password.

**Note** Some networks do not broadcast their existence. To connect to such a network, select *Add network...* and set all parameters manually according to that network.

## 7.23 Changing the settings

### 7.23.1 General

You can change a variety of settings for the camera.

The *Settings* menu includes the following:

- *Measurement parameters.*
- *Camera temperature range.*
- *Save options.*
- *Device settings.*

#### 7.23.1.1 Measurement parameters

- *Emissivity.*
- *Reflected temperature.*
- *Distance.*

#### 7.23.1.2 Camera temperature range

For accurate temperature measurements, you must change the *Camera temperature range* setting to suit the expected temperature of the object you are inspecting.

Available temperature range options are dependent on the camera model. The unit (°C or °F) depends on the temperature unit setting, see section 7.23.1.4 *Device settings*, page 24.

---

### 7.23.1.3 Save options

- *Photo as separate JPEG*: When this menu command is selected, the digital photo from the visual camera is saved at its full field of view as a separate JPEG image.

### 7.23.1.4 Device settings

- *Language, time & units*:
  - *Language*.
  - *Temperature unit*.
  - *Distance unit*.
  - *Date & time*.
  - *Date & time format*.
- *Wi-Fi*
  - *Off*
  - *Share*
  - *Connect to network*
    - *Networks*
- *Reset options*:
  - *Reset default camera mode*.
  - *Reset device settings to factory default*.
  - *Delete all saved images*.
- *Auto power off*.
- *Display intensity*.
- *Demonstration mode*: This menu command provides a camera mode that displays various images without any user interventions. The camera mode is intended for demonstration purposes or when displaying the camera in a store.
  - *Off*.
  - *Electrical applications*.
  - *Building applications*.
- *Camera information*: This menu command displays various items of information about the camera, such as the model, serial number, and software version.

### 7.23.2 Procedure

Follow this procedure:

1. Push the center of the navigation pad. This displays a toolbar.
2. On the toolbar, select *Settings* . This displays a dialog box.
3. In the dialog box, select the setting that you want to change and use the navigation pad to display additional dialog boxes.

## 7.24 Updating the camera

### 7.24.1 General

To take advantage of our latest camera firmware, it is important that you keep your camera updated. You update your camera using FLIR Tools.

### 7.24.2 Procedure

Follow this procedure:

1. Start FLIR Tools.
2. Start the camera.
3. Connect the camera to the computer using the USB cable.
4. On the *Help* menu in FLIR Tools, click *Check for updates*.
5. Follow the on-screen instructions.



[See next page]

Camera with built-in IR lens f=6,5 mm (45°)

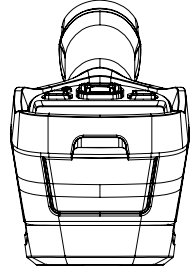
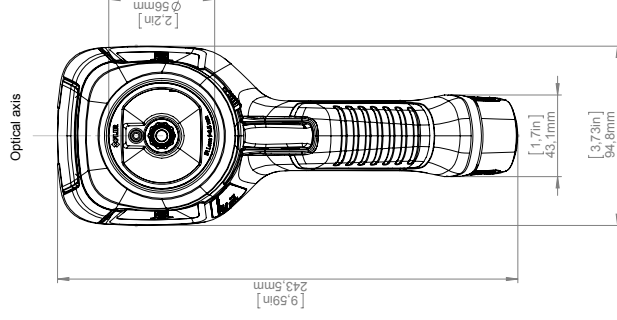
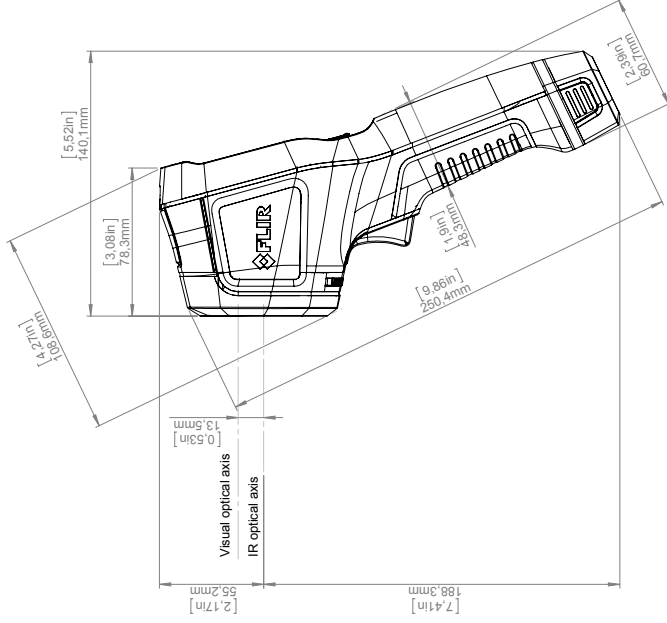
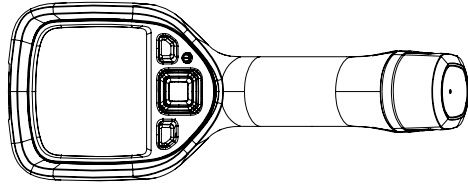
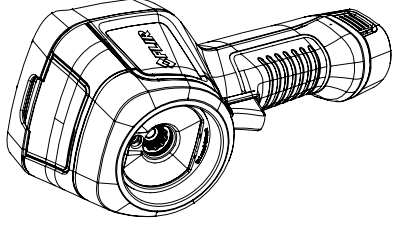
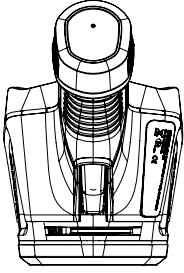

# Charger and Power pack

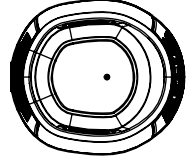
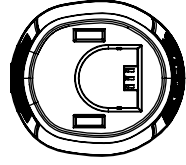
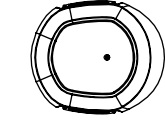
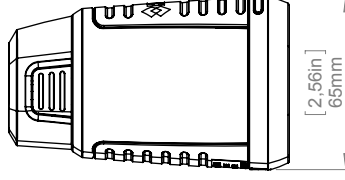
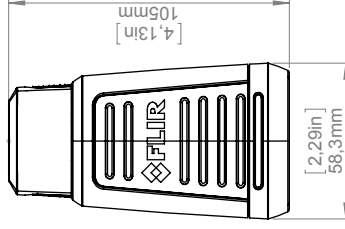
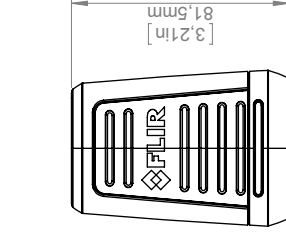
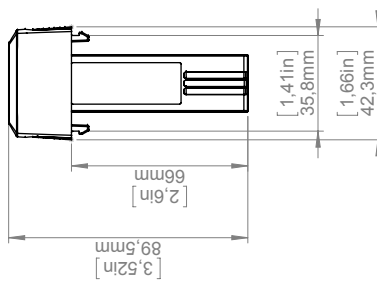
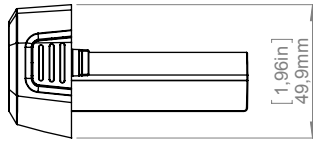
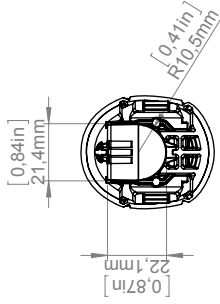
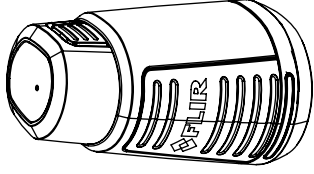
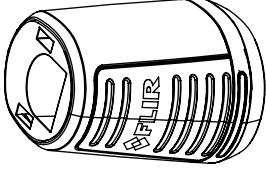
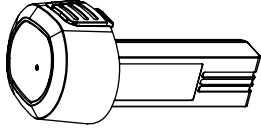

Modified 2013-03-25		Check CAHA	Drawn by R&D Thermography	Size A3	FLIR
Denomination		Basic dimensions FLIR Ex		Scale 1:2	Sheet 2(2)
				Drawing No. T127831	Size A

[See next page]



## 10.1 Camera housing, cables, and other items

### 10.1.1 Liquids

Use one of these liquids:

- Warm water
- A weak detergent solution

### 10.1.2 Equipment

A soft cloth

### 10.1.3 Procedure

Follow this procedure:

1. Soak the cloth in the liquid.
2. Twist the cloth to remove excess liquid.
3. Clean the part with the cloth.



#### CAUTION

Do not apply solvents or similar liquids to the camera, the cables, or other items. This can cause damage.

## 10.2 Infrared lens

### 10.2.1 Liquids

Use one of these liquids:

- A commercial lens cleaning liquid with more than 30% isopropyl alcohol.
- 96% ethyl alcohol (C<sub>2</sub>H<sub>5</sub>OH).

### 10.2.2 Equipment

Cotton wool



#### CAUTION

If you use a lens cleaning cloth it must be dry. Do not use a lens cleaning cloth with the liquids that are given in section 10.2.1 above. These liquids can cause material on the lens cleaning cloth to become loose. This material can have an unwanted effect on the surface of the lens.

### 10.2.3 Procedure

Follow this procedure:

1. Soak the cotton wool in the liquid.
2. Twist the cotton wool to remove excess liquid.
3. Clean the lens one time only and discard the cotton wool.



#### WARNING

Make sure that you read all applicable MSDS (Material Safety Data Sheets) and warning labels on containers before you use a liquid: the liquids can be dangerous.



#### CAUTION

- Be careful when you clean the infrared lens. The lens has a delicate anti-reflective coating.
- Do not clean the infrared lens too vigorously. This can damage the anti-reflective coating.

## 11.1 Moisture & water damage

### 11.1.1 General

It is often possible to detect moisture and water damage in a house by using an infrared camera. This is partly because the damaged area has a different heat conduction property and partly because it has a different thermal capacity to store heat than the surrounding material.

Many factors can come into play as to how moisture or water damage will appear in an infrared image.

For example, heating and cooling of these parts takes place at different rates depending on the material and the time of day. For this reason, it is important that other methods are used as well to check for moisture or water damage.

### 11.1.2 Figure

The image below shows extensive water damage on an external wall where the water has penetrated the outer facing because of an incorrectly installed window ledge.

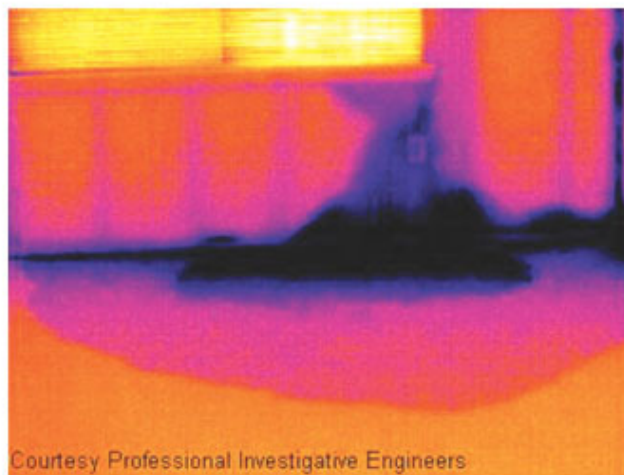

## 11.2 Faulty contact in socket

### 11.2.1 General

Depending on the type of connection a socket has, an improperly connected wire can result in local temperature increase. This temperature increase is caused by the reduced contact area between the connection point of the incoming wire and the socket, and can result in an electrical fire.

A socket's construction may differ dramatically from one manufacturer to another. For this reason, different faults in a socket can lead to the same typical appearance in an infrared image.

Local temperature increase can also result from improper contact between wire and socket, or from difference in load.

### 11.2.2 Figure

The image below shows a connection of a cable to a socket where improper contact in the connection has resulted in local temperature increase.

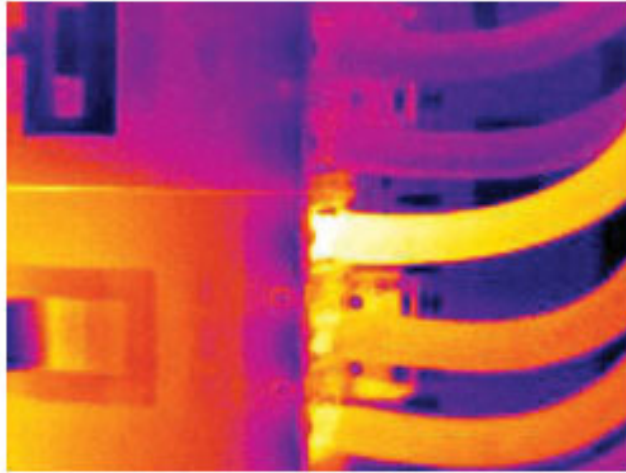

## 11.3 Oxidized socket

### 11.3.1 General

Depending on the type of socket and the environment in which the socket is installed, oxides may occur on the socket's contact surfaces. These oxides can lead to locally increased resistance when the socket is loaded, which can be seen in an infrared image as local temperature increase.

A socket's construction may differ dramatically from one manufacturer to another. For this reason, different faults in a socket can lead to the same typical appearance in an infrared image.

Local temperature increase can also result from improper contact between a wire and socket, or from difference in load.

### 11.3.2 Figure

The image below shows a series of fuses where one fuse has a raised temperature on the contact surfaces against the fuse holder. Because of the fuse holder's blank metal, the temperature increase is not visible there, while it is visible on the fuse's ceramic material.

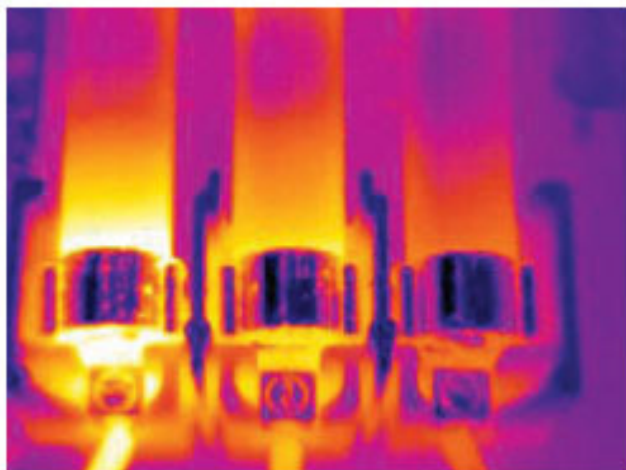



---

## 11.4 Insulation deficiencies

### 11.4.1 General

Insulation deficiencies may result from insulation losing volume over the course of time and thereby not entirely filling the cavity in a frame wall.

An infrared camera allows you to see these insulation deficiencies because they either have a different heat conduction property than sections with correctly installed insulation, and/or show the area where air is penetrating the frame of the building.

When you are inspecting a building, the temperature difference between the inside and outside should be at least 10°C (18°F). Studs, water pipes, concrete columns, and similar components may resemble an insulation deficiency in an infrared image. Minor differences may also occur naturally.

### 11.4.2 Figure

In the image below, insulation in the roof framing is lacking. Due to the absence of insulation, air has forced its way into the roof structure, which thus takes on a different characteristic appearance in the infrared image.

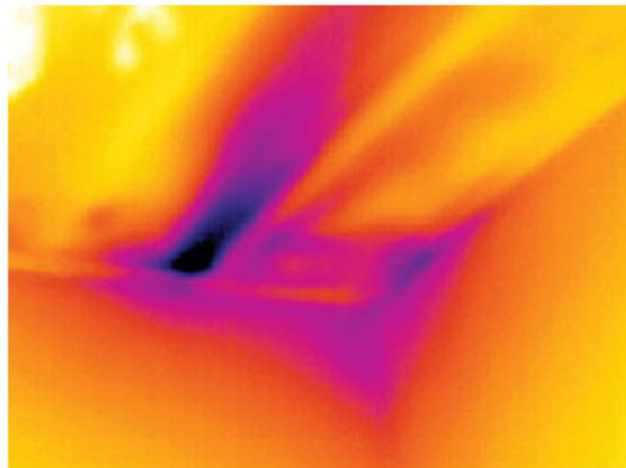

## 11.5 Draft

### 11.5.1 General

Draft can be found under baseboards, around door and window casings, and above ceiling trim. This type of draft is often possible to see with an infrared camera, as a cooler airstream cools down the surrounding surface.

When you are investigating draft in a house, there should be sub-atmospheric pressure in the house. Close all doors, windows, and ventilation ducts, and allow the kitchen fan to run for a while before you take the infrared images.

An infrared image of draft often shows a typical stream pattern. You can see this stream pattern clearly in the picture below.

Also keep in mind that drafts can be concealed by heat from floor heating circuits.

### 11.5.2 Figure

The image below shows a ceiling hatch where faulty installation has resulted in a strong draft.

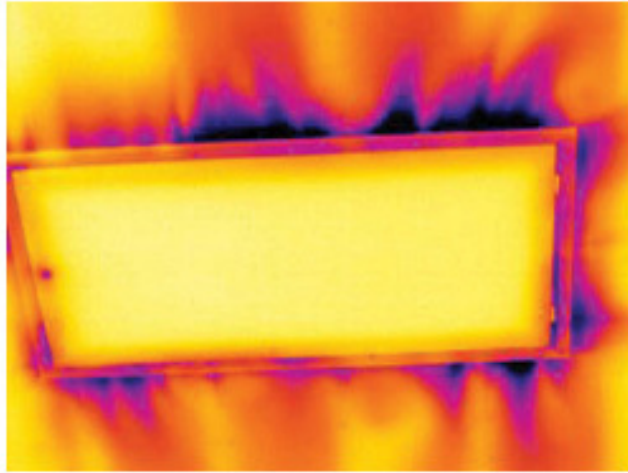

## 12.1 Introduction

An infrared camera measures and images the emitted infrared radiation from an object. The fact that radiation is a function of object surface temperature makes it possible for the camera to calculate and display this temperature.

However, the radiation measured by the camera does not only depend on the temperature of the object but is also a function of the emissivity. Radiation also originates from the surroundings and is reflected in the object. The radiation from the object and the reflected radiation will also be influenced by the absorption of the atmosphere.

To measure temperature accurately, it is therefore necessary to compensate for the effects of a number of different radiation sources. This is done on-line automatically by the camera. The following object parameters must, however, be supplied for the camera:

- The emissivity of the object
- The reflected apparent temperature
- The distance between the object and the camera
- The relative humidity
- Temperature of the atmosphere

## 12.2 Emissivity

The most important object parameter to set correctly is the emissivity which, in short, is a measure of how much radiation is emitted from the object, compared to that from a perfect blackbody of the same temperature.

Normally, object materials and surface treatments exhibit emissivity ranging from approximately 0.1 to 0.95. A highly polished (mirror) surface falls below 0.1, while an oxidized or painted surface has a higher emissivity. Oil-based paint, regardless of color in the visible spectrum, has an emissivity over 0.9 in the infrared. Human skin exhibits an emissivity 0.97 to 0.98.

Non-oxidized metals represent an extreme case of perfect opacity and high reflexivity, which does not vary greatly with wavelength. Consequently, the emissivity of metals is low – only increasing with temperature. For non-metals, emissivity tends to be high, and decreases with temperature.

### 12.2.1 Finding the emissivity of a sample

#### 12.2.1.1 *Step 1: Determining reflected apparent temperature*

Use one of the following two methods to determine reflected apparent temperature:

## 12.2.1.1.1 Method 1: Direct method

Follow this procedure:

1. Look for possible reflection sources, considering that the incident angle = reflection angle ( $a = b$ ).

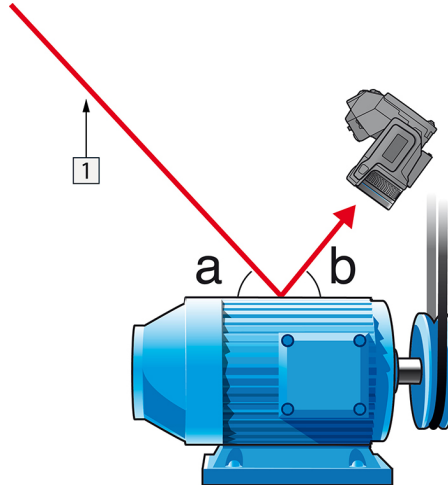

Figure 12.1 1 = Reflection source

2. If the reflection source is a spot source, modify the source by obstructing it using a piece of cardboard.

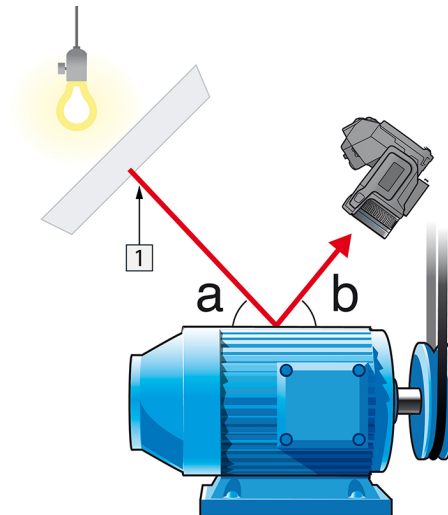

Figure 12.2 1 = Reflection source

3. Measure the radiation intensity (= apparent temperature) from the reflection source using the following settings:

- Emissivity: 1.0
- $D_{obj}$ : 0

You can measure the radiation intensity using one of the following two methods:

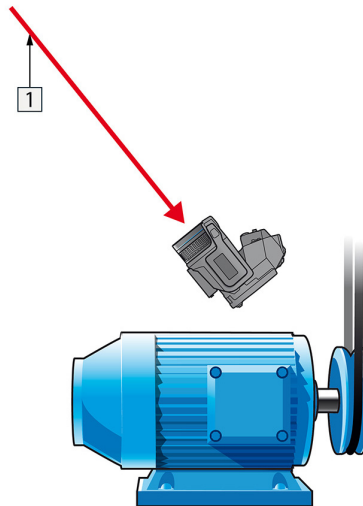

Figure 12.3 1 = Reflection source

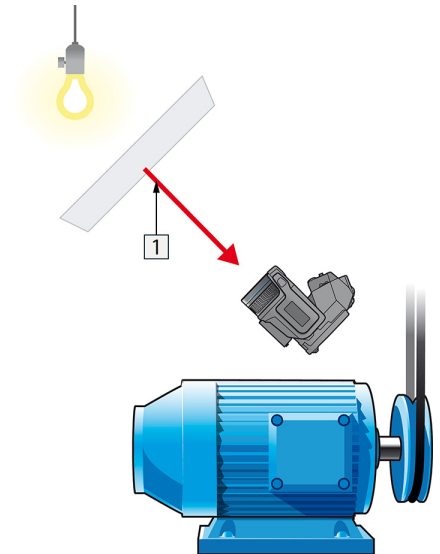

Figure 12.4 1 = Reflection source

You can not use a thermocouple to measure reflected apparent temperature, because a thermocouple measures *temperature*, but apparent temperature is *radiation intensity*.

#### 12.2.1.1.2 Method 2: Reflector method

Follow this procedure:

1. Crumble up a large piece of aluminum foil.
2. Uncrumble the aluminum foil and attach it to a piece of cardboard of the same size.
3. Put the piece of cardboard in front of the object you want to measure. Make sure that the side with aluminum foil points to the camera.
4. Set the emissivity to 1.0.

5. Measure the apparent temperature of the aluminum foil and write it down. The foil is considered a perfect reflector, so its apparent temperature equals the reflected apparent temperature from the surroundings.

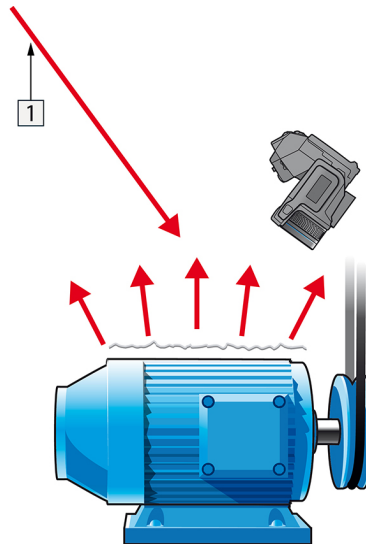

**Figure 12.5** Measuring the apparent temperature of the aluminum foil.

### 12.2.1.2 Step 2: Determining the emissivity

Follow this procedure:

1. Select a place to put the sample.
2. Determine and set reflected apparent temperature according to the previous procedure.
3. Put a piece of electrical tape with known high emissivity on the sample.
4. Heat the sample at least 20 K above room temperature. Heating must be reasonably even.
5. Focus and auto-adjust the camera, and freeze the image.
6. Adjust *Level* and *Span* for best image brightness and contrast.
7. Set emissivity to that of the tape (usually 0.97).
8. Measure the temperature of the tape using one of the following measurement functions:
  - *Isotherm* (helps you to determine both the temperature and how evenly you have heated the sample)
  - *Spot* (simpler)
  - *Box Avg* (good for surfaces with varying emissivity).
9. Write down the temperature.
10. Move your measurement function to the sample surface.
11. Change the emissivity setting until you read the same temperature as your previous measurement.
12. Write down the emissivity.

#### Note

- Avoid forced convection
- Look for a thermally stable surrounding that will not generate spot reflections
- Use high quality tape that you know is not transparent, and has a high emissivity you are certain of
- This method assumes that the temperature of your tape and the sample surface are the same. If they are not, your emissivity measurement will be wrong.

### 12.3 Reflected apparent temperature

This parameter is used to compensate for the radiation reflected in the object. If the emissivity is low and the object temperature relatively far from that of the reflected it will be important to set and compensate for the reflected apparent temperature correctly.

### 12.4 Distance

The distance is the distance between the object and the front lens of the camera. This parameter is used to compensate for the following two facts:

- That radiation from the target is absorbed by the atmosphere between the object and the camera.
- That radiation from the atmosphere itself is detected by the camera.

### 12.5 Relative humidity

The camera can also compensate for the fact that the transmittance is also dependent on the relative humidity of the atmosphere. To do this set the relative humidity to the correct value. For short distances and normal humidity the relative humidity can normally be left at a default value of 50%.

### 12.6 Other parameters

In addition, some cameras and analysis programs from FLIR Systems allow you to compensate for the following parameters:

- Atmospheric temperature – *i.e.* the temperature of the atmosphere between the camera and the target
- External optics temperature – *i.e.* the temperature of any external lenses or windows used in front of the camera
- External optics transmittance – *i.e.* the transmission of any external lenses or windows used in front of the camera

## 13.1 Introduction

Calibration of a thermal camera is a prerequisite for temperature measurement. The calibration provides the relationship between the input signal and the physical quantity that the user wants to measure. However, despite its widespread and frequent use, the term “calibration” is often misunderstood and misused. Local and national differences as well as translation-related issues create additional confusion.

Unclear terminology can lead to difficulties in communication and erroneous translations, and subsequently to incorrect measurements due to misunderstandings and, in the worst case, even to lawsuits.

## 13.2 Definition—what is calibration?

The International Bureau of Weights and Measures<sup>2</sup> defines *calibration*<sup>3</sup> in the following way:

an operation that, under specified conditions, in a first step, establishes a relation between the quantity values with measurement uncertainties provided by measurement standards and corresponding indications with associated measurement uncertainties and, in a second step, uses this information to establish a relation for obtaining a measurement result from an indication.

The calibration itself may be expressed in different formats: this can be a statement, calibration function, calibration diagram<sup>4</sup>, calibration curve<sup>5</sup>, or calibration table.

Often, the first step alone in the above definition is perceived and referred to as being “calibration.” However, this is not (always) sufficient.

Considering the calibration procedure of a thermal camera, the first step establishes the relation between emitted radiation (the quantity value) and the electrical output signal (the indication). This first step of the calibration procedure consists of obtaining a homogeneous (or uniform) response when the camera is placed in front of an extended source of radiation.

As we know the temperature of the reference source emitting the radiation, in the second step the obtained output signal (the indication) can be related to the reference source’s temperature (measurement result). The second step includes drift measurement and compensation.

To be correct, calibration of a thermal camera is, strictly, not expressed through temperature. Thermal cameras are sensitive to infrared radiation: therefore, at first you obtain a radiance correspondence, then a relationship between radiance and temperature. For bolometer cameras used by non-R&D customers, radiance is not expressed: only the temperature is provided.

## 13.3 Camera calibration at FLIR Systems

Without calibration, an infrared camera would not be able to measure either radiance or temperature. At FLIR Systems, the calibration of uncooled microbolometer cameras with a measurement capability is carried out during both production and service. Cooled cameras with photon detectors are often calibrated by the user with special software. With this type of software, in theory, common handheld uncooled thermal cameras could be calibrated by the user too. However, as this software is not suitable for reporting

---

2. <http://www.bipm.org/en/about-us/> [Retrieved 2017-01-31.]

3. <http://jcgem.bipm.org/vim/en/2.39.html> [Retrieved 2017-01-31.]

4. <http://jcgem.bipm.org/vim/en/4.30.html> [Retrieved 2017-01-31.]

5. <http://jcgem.bipm.org/vim/en/4.31.html> [Retrieved 2017-01-31.]



---

purposes, most users do not have it. Non-measuring devices that are used for imaging only do not need temperature calibration. Sometimes this is also reflected in camera terminology when talking about infrared or thermal imaging cameras compared with thermography cameras, where the latter are the measuring devices.

The calibration information, no matter if the calibration is done by FLIR Systems or the user, is stored in calibration curves, which are expressed by mathematical functions. As radiation intensity changes with both temperature and the distance between the object and the camera, different curves are generated for different temperature ranges and exchangeable lenses.

### 13.4 The differences between a calibration performed by a user and that performed directly at FLIR Systems

First, the reference sources that FLIR Systems uses are themselves calibrated and traceable. This means, at each FLIR Systems site performing calibration, that the sources are controlled by an independent national authority. The camera calibration certificate is confirmation of this. It is proof that not only has the calibration been performed by FLIR Systems but that it has also been carried out using calibrated references. Some users own or have access to accredited reference sources, but they are very few in number.

Second, there is a technical difference. When performing a user calibration, the result is often (but not always) not drift compensated. This means that the values do not take into account a possible change in the camera's output when the camera's internal temperature varies. This yields a larger uncertainty. Drift compensation uses data obtained in climate-controlled chambers. All FLIR Systems cameras are drift compensated when they are first delivered to the customer and when they are recalibrated by FLIR Systems service departments.

### 13.5 Calibration, verification and adjustment

A common misconception is to confuse *calibration* with *verification* or *adjustment*. Indeed, calibration is a prerequisite for *verification*, which provides confirmation that specified requirements are met. Verification provides objective evidence that a given item fulfills specified requirements. To obtain the verification, defined temperatures (emitted radiation) of calibrated and traceable reference sources are measured. The measurement results, including the deviation, are noted in a table. The verification certificate states that these measurement results meet specified requirements. Sometimes, companies or organizations offer and market this verification certificate as a "calibration certificate."

Proper verification—and by extension calibration and/or recalibration—can only be achieved when a validated protocol is respected. The process is more than placing the camera in front of blackbodies and checking if the camera output (as temperature, for instance) corresponds to the original calibration table. It is often forgotten that a camera is not sensitive to temperature but to radiation. Furthermore, a camera is an *imaging* system, not just a single sensor. Consequently, if the optical configuration allowing the camera to "collect" radiance is poor or misaligned, then the "verification" (or calibration or recalibration) is worthless.

For instance, one has to ensure that the distance between the blackbody and the camera as well as the diameter of the blackbody cavity are chosen so as to reduce stray radiation and the size-of-source effect.

To summarize: a validated protocol must comply with the physical laws for *radiance*, and not only those for temperature.

Calibration is also a prerequisite for *adjustment*, which is the set of operations carried out on a measuring system such that the system provides prescribed indications corresponding to given values of quantities to be measured, typically obtained from measurement standards. Simplified, adjustment is a manipulation that results in instruments that measure correctly within their specifications. In everyday language, the term “calibration” is widely used instead of “adjustment” for measuring devices.

## 13.6 Non-uniformity correction

When the thermal camera displays “Calibrating...” it is adjusting for the deviation in response of each individual detector element (pixel). In thermography, this is called a “non-uniformity correction” (NUC). It is an offset update, and the gain remains unchanged.

The European standard EN 16714-3, Non-destructive Testing—Thermographic Testing—Part 3: Terms and Definitions, defines an NUC as “Image correction carried out by the camera software to compensate for different sensitivities of detector elements and other optical and geometrical disturbances.”

During the NUC (the offset update), a shutter (internal flag) is placed in the optical path, and all the detector elements are exposed to the same amount of radiation originating from the shutter. Therefore, in an ideal situation, they should all give the same output signal. However, each individual element has its own response, so the output is not uniform. This deviation from the ideal result is calculated and used to mathematically perform an image correction, which is essentially a correction of the displayed radiation signal. Some cameras do not have an internal flag. In this case, the offset update must be performed manually using special software and an external uniform source of radiation.

An NUC is performed, for example, at start-up, when changing a measurement range, or when the environment temperature changes. Some cameras also allow the user to trigger it manually. This is useful when you have to perform a critical measurement with as little image disturbance as possible.

## 13.7 Thermal image adjustment (thermal tuning)

Some people use the term “image calibration” when adjusting the thermal contrast and brightness in the image to enhance specific details. During this operation, the temperature interval is set in such a way that all available colors are used to show only (or mainly) the temperatures in the region of interest. The correct term for this manipulation is “thermal image adjustment” or “thermal tuning”, or, in some languages, “thermal image optimization.” You must be in manual mode to undertake this, otherwise the camera will set the lower and upper limits of the displayed temperature interval automatically to the coldest and hottest temperatures in the scene.

FLIR Systems was established in 1978 to pioneer the development of high-performance infrared imaging systems, and is the world leader in the design, manufacture, and marketing of thermal imaging systems for a wide variety of commercial, industrial, and government applications. Today, FLIR Systems embraces five major companies with outstanding achievements in infrared technology since 1958—the Swedish AGEMA Infrared Systems (formerly AGA Infrared Systems), the three United States companies In-digo Systems, FSI, and Inframetrics, and the French company Cedic.

Since 2007, FLIR Systems has acquired several companies with world-leading expertise in sensor technologies:

- Extech Instruments (2007)
- Ifara Tecnologías (2008)
- Salvador Imaging (2009)
- OmniTech Partners (2009)
- Directed Perception (2009)
- Raymarine (2010)
- ICx Technologies (2010)
- TackTick Marine Digital Instruments (2011)
- Aerius Photonics (2011)
- Lorex Technology (2012)
- Traficon (2012)
- MARSS (2013)
- DigitalOptics micro-optics business (2013)
- DVTel (2015)
- Point Grey Research (2016)
- Prox Dynamics (2016)

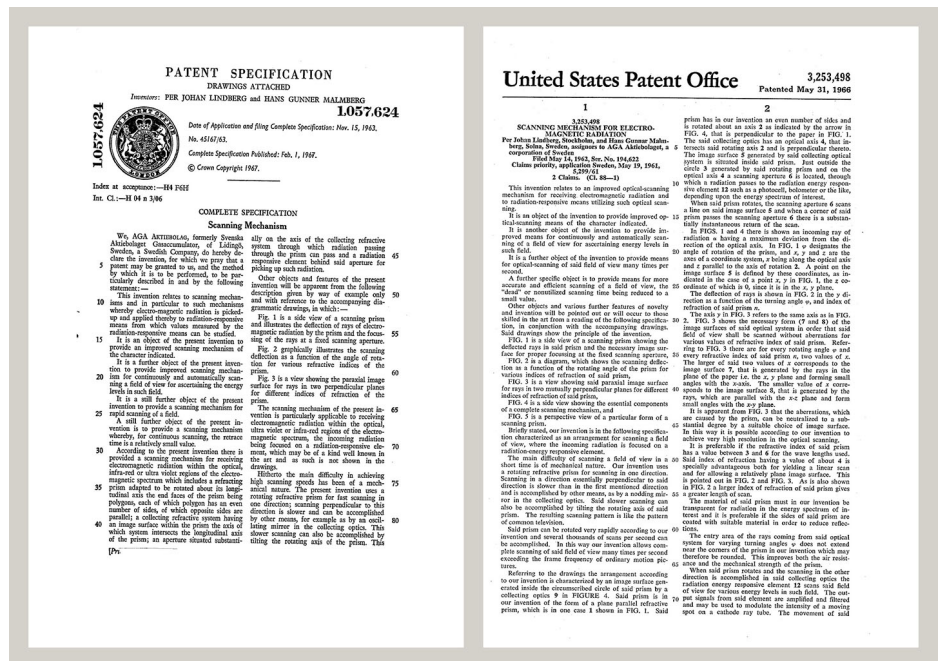

Figure 14.1 Patent documents from the early 1960s

FLIR Systems has three manufacturing plants in the United States (Portland, OR, Boston, MA, Santa Barbara, CA) and one in Sweden (Stockholm). Since 2007 there is also a manufacturing plant in Tallinn, Estonia. Direct sales offices in Belgium, Brazil, China, France, Germany, Great Britain, Hong Kong, Italy, Japan, Korea, Sweden, and the USA—together with a worldwide network of agents and distributors—support our international customer base.

FLIR Systems is at the forefront of innovation in the infrared camera industry. We anticipate market demand by constantly improving our existing cameras and developing new ones. The company has set milestones in product design and development such as the introduction of the first battery-operated portable camera for industrial inspections, and the first uncooled infrared camera, to mention just two innovations.



**Figure 14.2** 1969: Thermovision Model 661. The camera weighed approximately 25 kg (55 lb.), the oscilloscope 20 kg (44 lb.), and the tripod 15 kg (33 lb.). The operator also needed a 220 VAC generator set, and a 10 L (2.6 US gallon) jar with liquid nitrogen. To the left of the oscilloscope the Polaroid attachment (6 kg (13 lb.)) can be seen.



**Figure 14.3** 2015: FLIR One, an accessory to iPhone and Android mobile phones. Weight: 90 g (3.2 oz.).

FLIR Systems manufactures all vital mechanical and electronic components of the camera systems itself. From detector design and manufacturing, to lenses and system electronics, to final testing and calibration, all production steps are carried out and supervised by our own engineers. The in-depth expertise of these infrared specialists ensures the accuracy and reliability of all vital components that are assembled into your infrared camera.

## 14.1 More than just an infrared camera

At FLIR Systems we recognize that our job is to go beyond just producing the best infrared camera systems. We are committed to enabling all users of our infrared camera systems to work more productively by providing them with the most powerful camera–software combination. Especially tailored software for predictive maintenance, R & D, and process monitoring is developed in-house. Most software is available in a wide variety of languages.

We support all our infrared cameras with a wide variety of accessories to adapt your equipment to the most demanding infrared applications.

## 14.2 Sharing our knowledge

Although our cameras are designed to be very user-friendly, there is a lot more to thermography than just knowing how to handle a camera. Therefore, FLIR Systems has founded the Infrared Training Center (ITC), a separate business unit, that provides certified training courses. Attending one of the ITC courses will give you a truly hands-on learning experience.

The staff of the ITC are also there to provide you with any application support you may need in putting infrared theory into practice.

### **14.3 Supporting our customers**

FLIR Systems operates a worldwide service network to keep your camera running at all times. If you discover a problem with your camera, local service centers have all the equipment and expertise to solve it within the shortest possible time. Therefore, there is no need to send your camera to the other side of the world or to talk to someone who does not speak your language.







---

**Copyright**

© 2019, FLIR Systems, Inc. All rights reserved worldwide.

**Disclaimer**

Specifications subject to change without further notice. Models and accessories subject to regional market considerations. License procedures may apply. Products described herein may be subject to US Export Regulations.

Publ. No.: T559828  
Release: AO  
Commit: 56381  
Head: 56381  
Language: en-US  
Modified: 2019-03-21  
Formatted: 2019-03-21